

PRD Series

Long sensing distance proximity sensor

Upgrade

Features

- Realization of long sensing distance
(1.5~2 times longer sensing distance guaranteed compared to existing models)
- Improved the noise resistance with dedicated IC
- Reverse power polarity, surge, overcurrent protection
- Long life cycle and reliable
- Red LED status indication
- IP67 rated waterproof structure (IEC standard)
- Replacer for micro switches and limit switches
- Cable Support adopted : For more reliable flexural strength of sensor/cable connecting part



⚠ Please read "Caution for your safety" in operation manual before using.



Specifications

DC 2-wire type

Model	PRDT12-4DO PRDT12-4DC PRDT12-4DO-V PRDT12-4DC-V PRDLT12-4DO PRDLT12-4DC PRDLT12-4DO-V PRDLT12-4DC-V PRDWT12-4DO PRDWT12-4DC PRDWT12-4DO-I PRDWT12-4DC-I PRDWT12-4DO-V PRDWT12-4DC-V PRDWT12-4DO-IV PRDWT12-4DC-IV	PRDT12-8DO PRDT12-8DC PRDT12-8DO-V PRDT12-8DC-V PRDLT12-8DO PRDLT12-8DC PRDLT12-8DO-V PRDLT12-8DC-V PRDWT12-8DO PRDWT12-8DC PRDWT12-8DO-I PRDWT12-8DC-I PRDWT12-8DO-V PRDWT12-8DC-V PRDWT12-8DO-IV PRDWT12-8DC-IV	PRDT18-7DO PRDT18-7DC PRDT18-7DO-V PRDT18-7DC-V PRDLT18-7DO PRDLT18-7DC PRDLT18-7DO-V PRDLT18-7DC-V PRDWT18-7DO PRDWT18-7DC PRDWT18-7DO-I PRDWT18-7DC-I PRDWT18-7DO-V PRDWT18-7DC-V PRDWT18-7DO-IV PRDWT18-7DC-IV	PRDT18-14DO PRDT18-14DC PRDT18-14DO-V PRDT18-14DC-V PRDLT18-14DO PRDLT18-14DC PRDLT18-14DO-V PRDLT18-14DC-V PRDWT18-14DO PRDWT18-14DC PRDWT18-14DO-I PRDWT18-14DC-I PRDWT18-14DO-V PRDWT18-14DC-V PRDWT18-14DO-IV PRDWT18-14DC-IV	PRDT30-15DO PRDT30-15DC PRDT30-15DO-V PRDT30-15DC-V PRDLT30-15DO PRDLT30-15DC PRDLT30-15DO-V PRDLT30-15DC-V PRDWT30-15DO PRDWT30-15DC PRDWT30-15DO-I PRDWT30-15DC-I PRDWT30-15DO-V PRDWT30-15DC-V PRDWT30-15DO-IV PRDWT30-15DC-IV	PRDT30-25DO PRDT30-25DC PRDT30-25DO-V PRDT30-25DC-V PRDLT30-25DO PRDLT30-25DC PRDLT30-25DO-V PRDLT30-25DC-V PRDWT30-25DO PRDWT30-25DC PRDWT30-25DO-I PRDWT30-25DC-I PRDWT30-25DO-V PRDWT30-25DC-V PRDWT30-25DO-IV PRDWT30-25DC-IV
Sensing distance	4mm ±10%	8mm ±10%	7mm ±10%	14mm ±10%	15mm ±10%	25mm ±10%
Hysteresis	Max. 10% of sensing distance					
Standard sensing target	12×12×1mm (Iron)	25×25×1mm (Iron)	20×20×1mm (Iron)	40×40×1mm (Iron)	45×45×1mm (Iron)	75×75×1mm (Iron)
Setting distance	0~2.8mm	0~5.6mm	0~4.9mm	0~9.8mm	0~10.5mm	0~17.5mm
Power supply (Operating voltage)	12-24VDC (10-30VDC)					
Leakage current	Max. 0.6mA					
Response frequency (*1)	450Hz	400Hz	250Hz	200Hz	100Hz	
Residual voltage	Max. 3.5V					
Affection by Temp.	Within ±10% max. of sensing distance at +20°C in temperature range of -25 to +70°C					
Control output	2 ~ 100mA					
Insulation resistance	Min. 50MΩ (at 500VDC megger)					
Dielectric strength	1500VAC 50/60Hz for 1minute					
Vibration	1mm amplitude at frequency of 10 ~ 55Hz in each of X, Y, Z directions for 2 hours					
Shock	500m/s ² (50G) X, Y, Z directions for 3 times					
Indicator	Operating indicator (Red LED)					
Ambient temperature	-25 ~ +70°C (non-freezing condition)					
Storage temperature	-30 ~ +80°C (non-freezing condition)					
Ambient humidity	35~95%RH (at non-dew status)					
Protection circuit	Surge protection circuit, Reverse polarity protection circuit, Overcurrent protection					
Materials	Case/Nut: Nickel plated Brass, Washer: Nickel plated Iron, Sensing surface: Heat-resistant ABS					
Approval	CE					
Protection	IP67 (IEC Standard)					
Unit weight	PRDT:Approx. 74g PRDLT:Approx. 94g PRDWT:Approx. 44g	PRDT:Approx. 72g PRDLT:Approx. 92g PRDWT:Approx. 42g	PRDT:Approx. 115g PRDLT:Approx. 145g PRDWT:Approx. 80g	PRDT:Approx. 110g PRDLT:Approx. 140g PRDWT:Approx. 75g	PRDT:Approx. 175g PRDLT:Approx. 215g PRDWT:Approx. 140g	PRDT:Approx. 180g PRDLT:Approx. 220g PRDWT:Approx. 145g

* (*1) The response frequency is the average value. The standard sensing target is used and the width is set as 2 times of the standard sensing target, 1/2 of the sensing distance for the distance.

Long Sensing Distance Type

■ Specifications

● DC 3-wire type

Model	PRD12-4DN PRD12-4DP PRD12-4DN2 PRD12-4DP2 PRDL12-4DN PRDL12-4DP PRDL12-4DN2 PRDL12-4DP2 PRDW12-4DN PRDW12-4DP PRDW12-4DN2 PRDW12-4DP2 PRDWL12-4DN PRDWL12-4DP PRDWL12-4DN2 PRDWL12-4DP2	PRD12-8DN PRD12-8DP PRD12-8DN2 PRD12-8DP2 PRDL12-8DN PRDL12-8DP PRDL12-8DN2 PRDL12-8DP2 PRDW12-8DN PRDW12-8DP PRDW12-8DN2 PRDW12-8DP2 PRDWL12-8DN PRDWL12-8DP PRDWL12-8DN2 PRDWL12-8DP2	PRD18-7DN PRD18-7DP PRD18-7DN2 PRD18-7DP2 PRDL18-7DN PRDL18-7DP PRDL18-7DN2 PRDL18-7DP2 PRDW18-7DN PRDW18-7DP PRDW18-7DN2 PRDW18-7DP2 PRDWL18-7DN PRDWL18-7DP PRDWL18-7DN2 PRDWL18-7DP2	PRD18-14DN PRD18-14DP PRD18-14DN2 PRD18-14DP2 PRDL18-14DN PRDL18-14DP PRDL18-14DN2 PRDL18-14DP2 PRDW18-14DN PRDW18-14DP PRDW18-14DN2 PRDW18-14DP2 PRDWL18-14DN PRDWL18-14DP PRDWL18-14DN2 PRDWL18-14DP2
Sensing distance	4mm ±10%	8mm ±10%	7mm ±10%	14mm ±10%
Hysteresis	Max. 10% of sensing distance			
Standard sensing target	12×12×1mm (Iron)	25×25×1mm (Iron)	20×20×1mm (Iron)	40×40×1mm (Iron)
Setting distance	0 to 2.8mm	0 to 5.6mm	0 to 4.9mm	0 to 9.8mm
Power supply (Operating voltage)	12-24VDC (10-30VDC)			
Current consumption	Max. 10mA			
Response frequency(*1)	500Hz	400Hz	300Hz	200Hz
Residual voltage	Max. 1.5V			
Affection by Temp.	Within ±10% max. of sensing distance at +20°C in temperature range of -25 to +70°C			
Control output	200mA			
Insulation resistance	Min. 50MΩ (at 500VDC megger)			
Dielectric strength	1500VAC 50/60Hz for 1minute			
Vibration	1mm amplitude at frequency of 10 ~ 55Hz in each of X, Y, Z directions for 2 hours			
Shock	500m/s ² (50G) X, Y, Z directions for 3 times			
Indicator	Operating indicator (Red LED)			
Ambient temperature	-25 ~ +70°C (non-freezing condition)			
Storage temperature	-30 ~ +80°C (non-freezing condition)			
Ambient humidity	35 ~ 95%RH			
Protection circuit	Surge, Reverse posser polarity, Overcurrent protection circuit			
Protection	IP67 (IEC Standard)			
Approval	CE			
Unit weight	PRD : Approx. 74g PRDL : Approx. 94g PRDW : Approx. 44g PRDWL : Approx. 64g	PRD : Approx. 72g PRDL : Approx. 92g PRDW : Approx. 42g PRDWL : Approx. 62g	PRD : Approx. 115g PRDL : Approx. 145g PRDW : Approx. 80g PRDWL : Approx. 110g	PRD : Approx. 110g PRDL : Approx. 140g PRDW : Approx. 75g PRDWL : Approx. 105g

*(*1) The response frequency is the average value. The standard sensing target is used and the width is set as 2 times of the standard sensing target, 1/2 of the sensing distance for the distance.

■ Dimensions

(Unit:mm)

● PRD(T)12-4D□

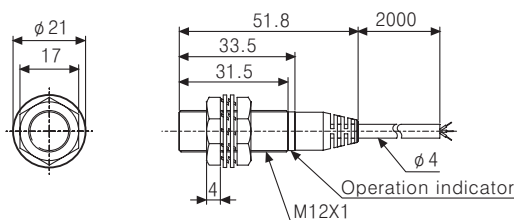

● PRD(T)12-8D□

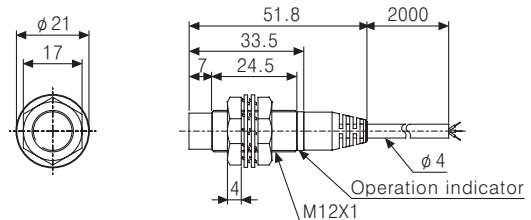

(A)
Counter

(B)
Timer

(C)
Temp.
controller

(D)
Power
controller

(E)
Panel
meter

(F)
Tacho/
Speed/
Pulse
meter

(G)
Display
unit

(H)
Sensor
controller

(I)
Switching
power
supply

(J)
Proximity
sensor

(K)
Photo
electric
sensor

(L)
Pressure
sensor

(M)
Rotary
encoder

(N)
Stepping
motor &
Driver &
Controller

(O)
Graphic
panel

(P)
Field
network
device

(Q)
Production
stoppage
models &
replacement

PRD Series

Dimensions

(Unit:mm)

●PRDL(T)12-4D□

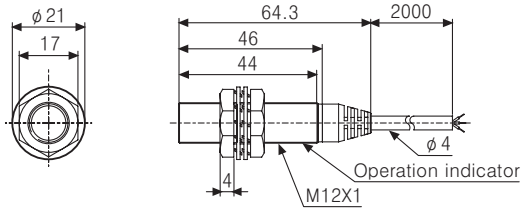

●PRDL(T)12-8D□

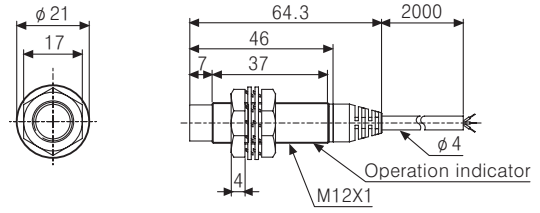

●PRD(T)18-7D□

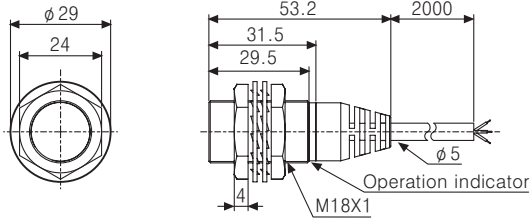

●PRD(T)18-14D□

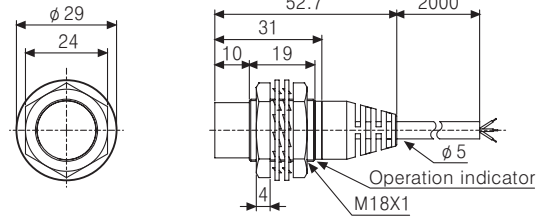

●PRDL(T)18-7D□

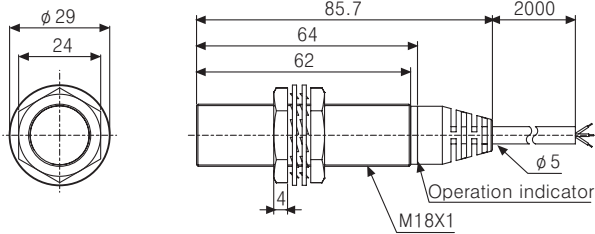

●PRDL(T)18-14D□

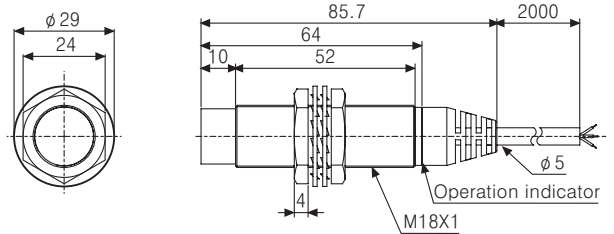

●PRD30T-15D□

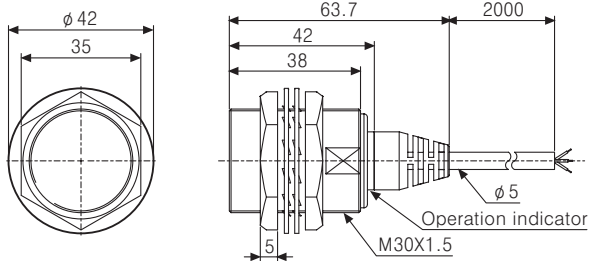

●PRD30T-25D□

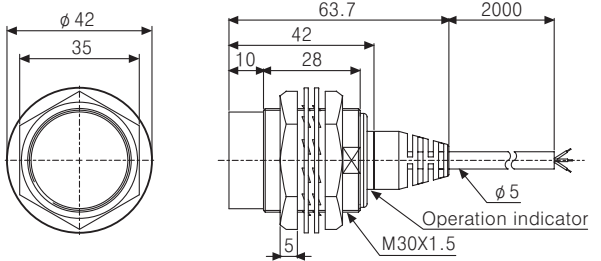

●PRDL30T-15D□

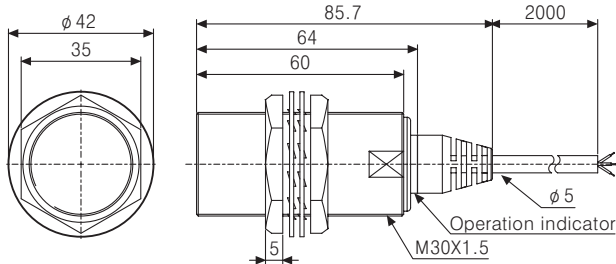

●PRDL30T-25D□

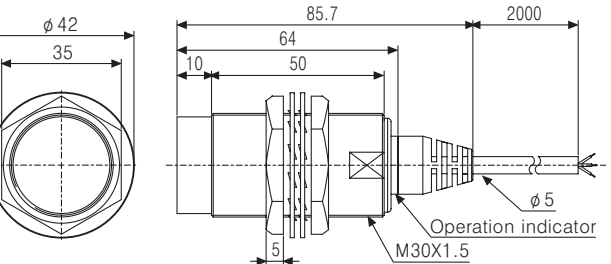

●PRDW(T)12-4D□

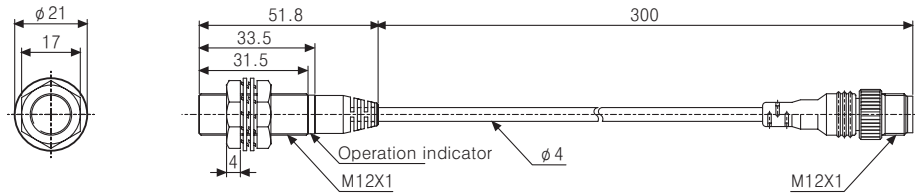

●PRDW(T)12-8D□

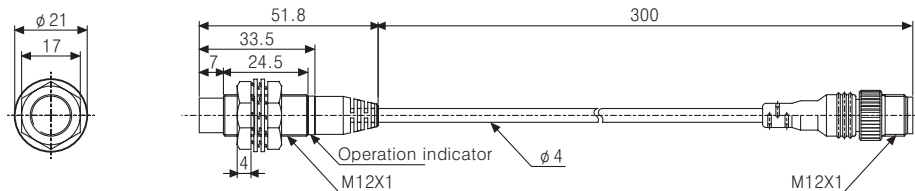

Long Sensing Distance Type

Dimensions

(Unit:mm)

● PRDW(T)18-7D□

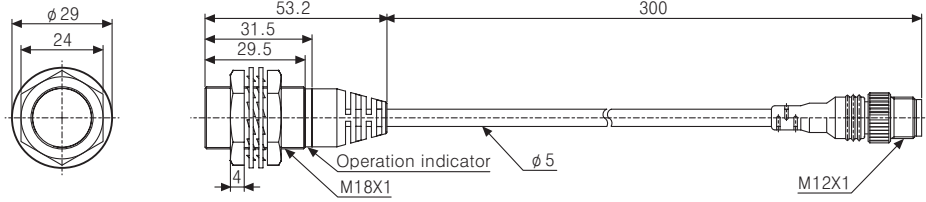

● PRDW(T)18-14D□

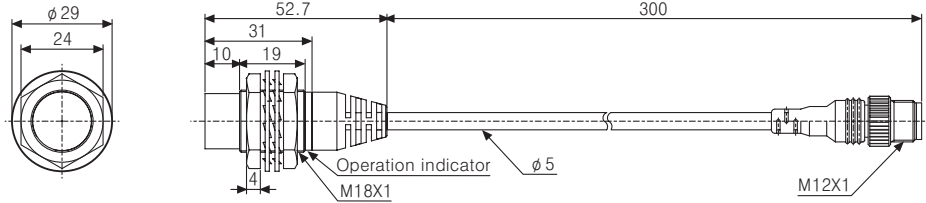

● PRDWL12-4D□

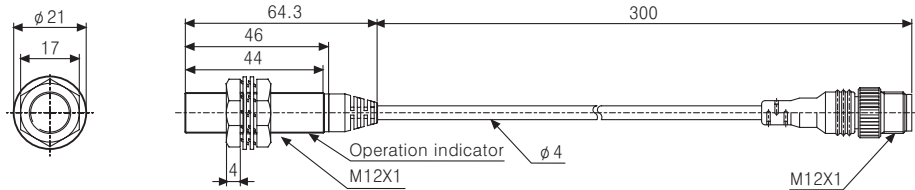

● PRDWL12-8D□

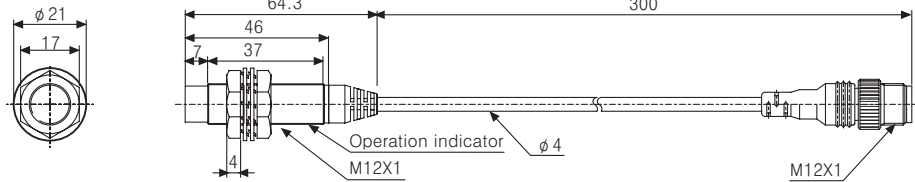

● PRDWL18-7D□

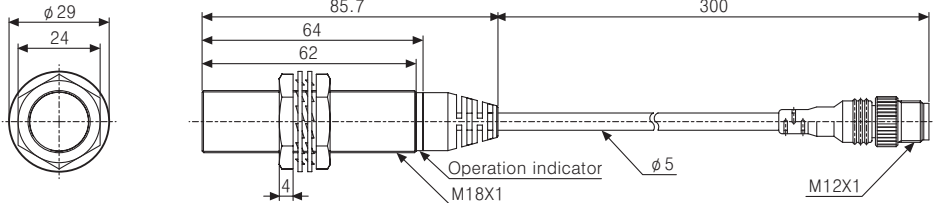

● PRDWL18-14D□

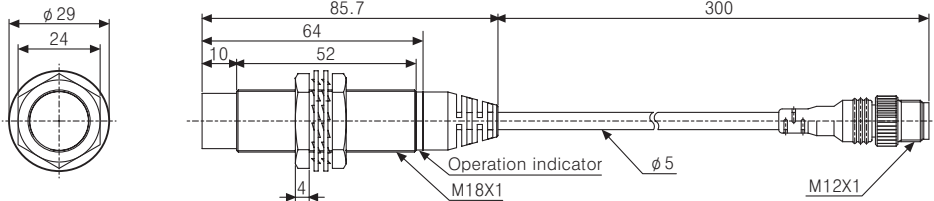

● PRDW30-15D□

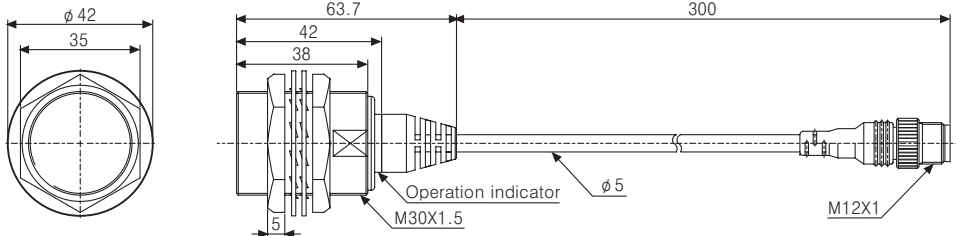

● PRDW30-25D□

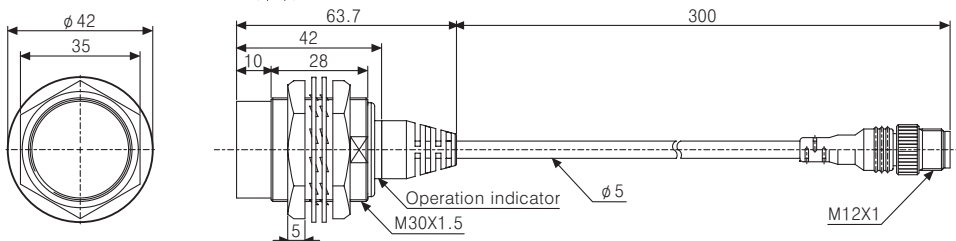

(A)
Counter

(B)
Timer

(C)
Temp.
controller

(D)
Power
controller

(E)
Panel
meter

(F)
Tacho/
Speed/
Pulse
meter

(G)
Display
unit

(H)
Sensor
controller

(I)
Switching
power
supply

(J)
Proximity
sensor

(K)
Photo
electric
sensor

(L)
Pressure
sensor

(M)
Rotary
encoder

(N)
Stepping
motor &
Driver &
Controller

(O)
Graphic
panel

(P)
Field
network
device

(Q)
Production
stoppage
models &
replacement

PRD Series

Dimensions

(Unit:mm)

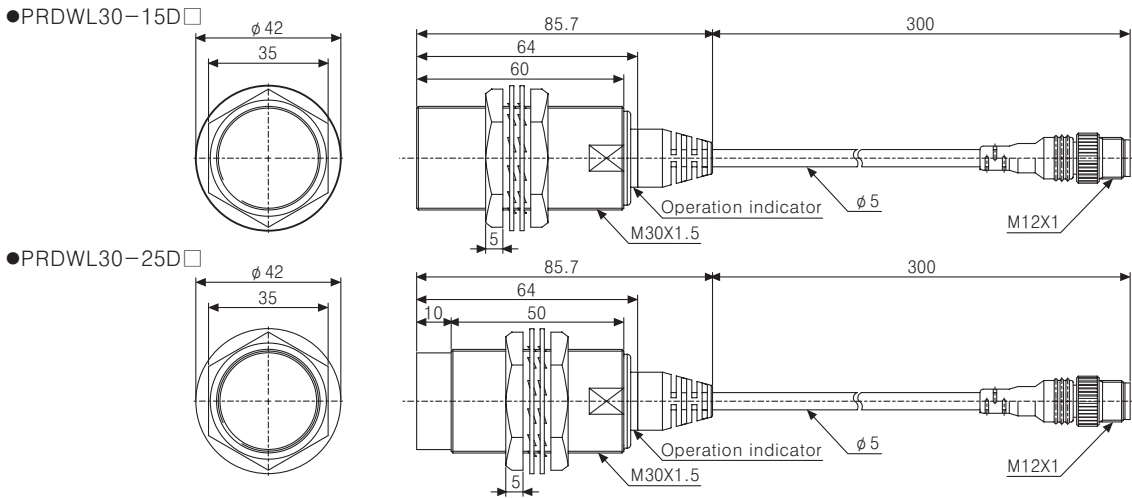

Control output diagram

DC 2-wire type

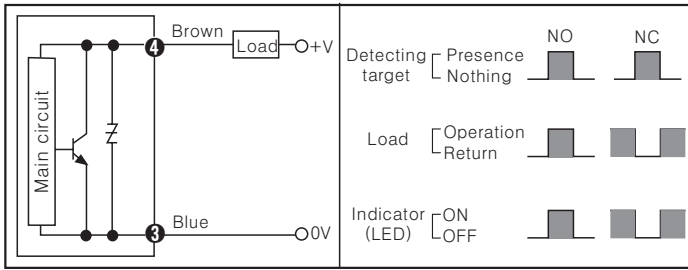

*The number in a circle is pin no. of connector.

DC 3-wire type

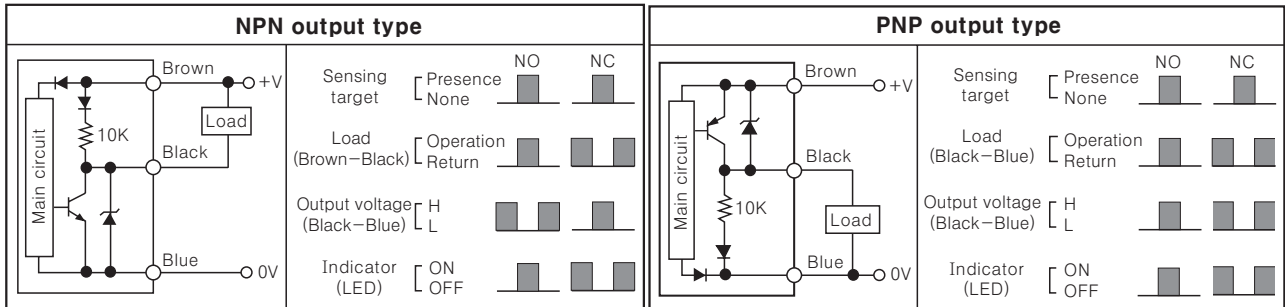

Connections

DC 2-wire type

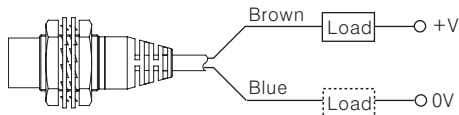

*The load can be connected to either wire.

DC 3-wire type

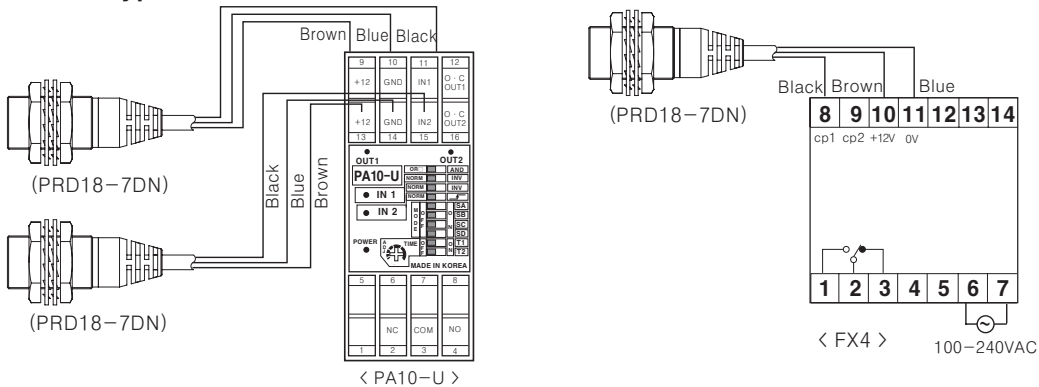

Long Sensing Distance Type

Wiring diagram

DC 2-wire type (Standard type)

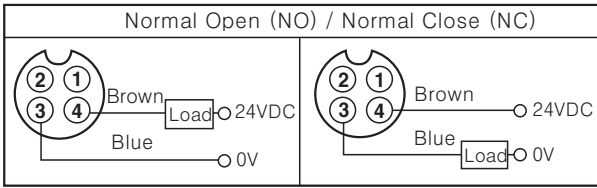

- *Pin ①, ② are N.C (Not Connected) terminals.
- *For DC 3-wire type connector cable, it is available to use with black wire (24VDC) and blue wire (0V).

DC 3-wire type

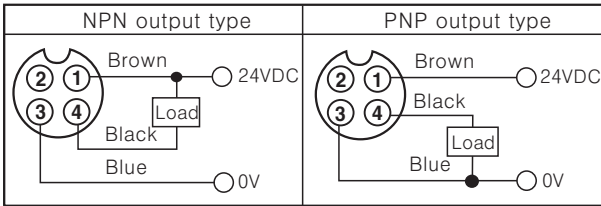

- *Please fasten the cleat of connector not to shown the thread. (0.39~0.49N・m)
- *Please fasten the vibration part with Teflon tape.
- *See J-51 about IEC standard connector wires and specifications.

DC 2-wire type (IEC standard type)

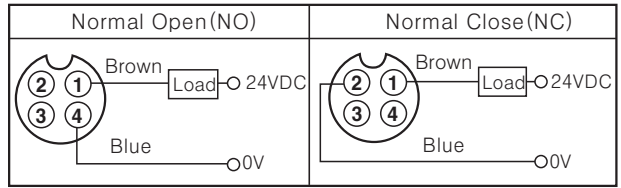

- *The pin arrangement of connector applying IEC standard is being developed.
- *Please attach "I" at the end of the name of standard type for purchasing the IEC standard product. Ex) PRDWT12-4DO-I
- *The connector cable for IEC standard is being developed. Please attach "I" at the end of the name of standard type. Ex) CID2-2-I, CLD2-5-I

Proper usage

Load connections

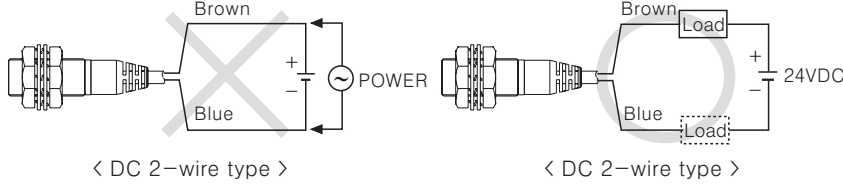

When using DC 2-wire type proximity sensor, the load must be connected otherwise internal components may be damaged. And the load can be connected to either wire.

In case of the load current is small

DC 2-wire type

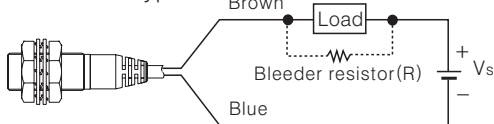

Please make the current on proximity sensor smaller than the return current of load by connecting a bleeder resistor in parallel.
*W value of Bleeder resistor should be bigger for proper heat dissipation.

$$R = \frac{V_s}{I_o - I_{off}} (\Omega) \quad P = \frac{V_s^2}{R} (W)$$

[Vs : Power supply, Io : Min. action current of proximity sensor
Ioff : Return current of load, P : Number of Bleeder resistance watt]

Mutual-interference

When several proximity sensors are mounted closely, malfunction of sensor may be caused due to mutual interference. Therefore, be sure to provide a minimum distance between the two sensors, as below charts.

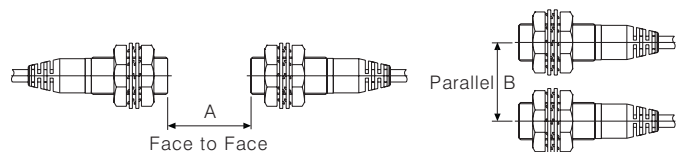

Influence by surrounding metals

When sensors are mounted on metallic panel, you must prevent the sensors from being affected by any metallic object except target. Therefore, be sure to provide a minimum distance as below chart.

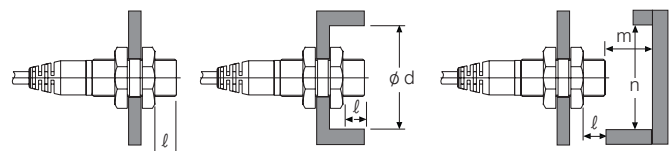

(Unit:mm)

Model	PRD□(T)12-4D□	PRD□(T)12-8D□	PRD□(T)18-7D□	PRD□(T)18-14D□	PRD□T30-15D□	PRD□T30-25D□
Item	PRDW□(T)12-4D□	PRDW□(T)12-8D□	PRDW□(T)18-7D□	PRDW□(T)18-14D□	PRDW□T30-15D□	PRDW□T30-25D□
A	24	48	42	84	90	150
B	24	36	36	54	60	90
l	0	11	0	14	0	15
φd	12	36	18	54	30	90
m	12	24	21	42	45	75
n	18	36	27	54	45	90

- (A) Counter
- (B) Timer
- (C) Temp. controller
- (D) Power controller
- (E) Panel meter
- (F) Tacho/Speed/Pulse meter
- (G) Display unit
- (H) Sensor controller
- (I) Switching power supply
- (J) Proximity sensor
- (K) Photo electric sensor
- (L) Pressure sensor
- (M) Rotary encoder
- (N) Stepping motor & Driver & Controller
- (O) Graphic panel
- (P) Field network device
- (Q) Production stoppage models & replacement