

**VOLTAGE input configuration and connecting
with MOD-8AI by RS485 Modbus.**

1. Open **MOD-8AI**:

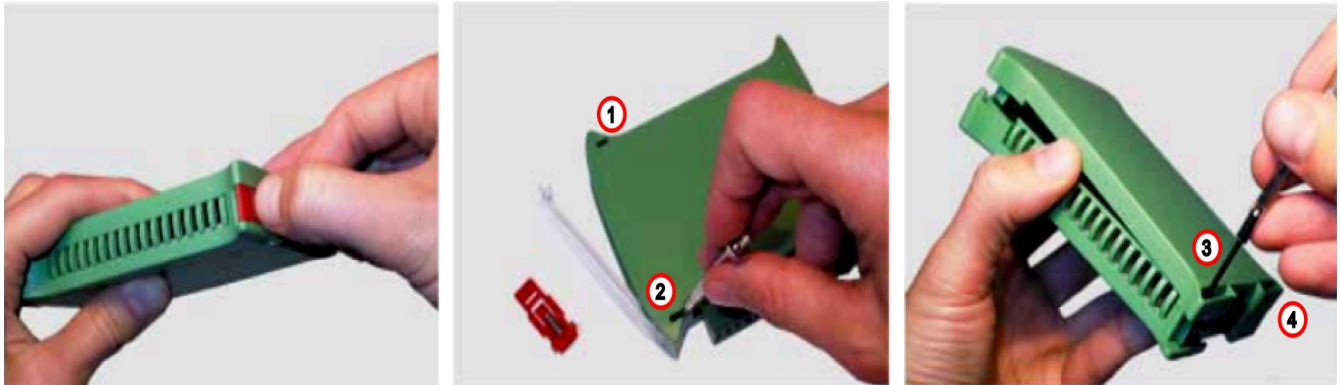

2. Set jumpers to **VOLTAGE** inputs. The channel with voltage input must have a open jumper.

Location of the jumpers

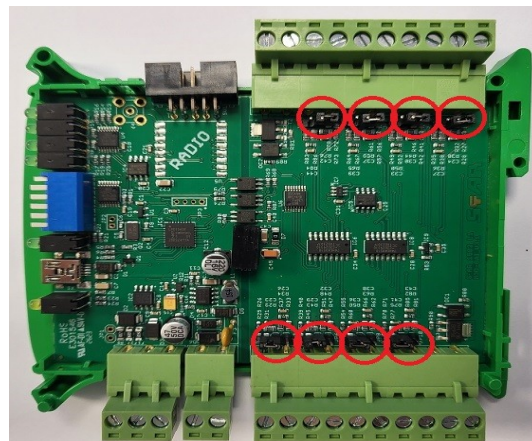
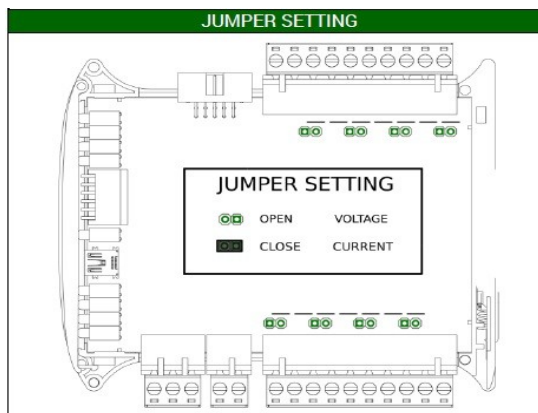

View of the open jumpers.

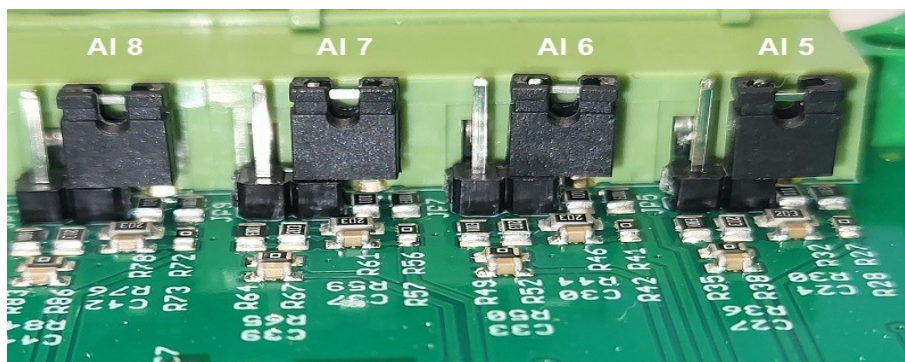

3. Close **MOD-8AI**
4. Connect power supply:

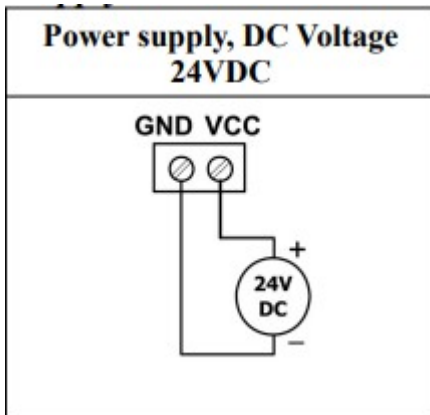

5. Connect MOD-8AI by USB cable and set type of input in IO Configurator.
Link to download:
https://www.aspar.com.pl/katalogi/IOMODULES/KONFIGURATOR/software/Konfigurator_IO.zip

The screenshot shows the IO Configurator software interface. The '8AI Module' tab is selected, and the 'Device type' is set to '8AI2DO'. The main configuration table is as follows:

Input status	Input mode	Register value	Value	Alarm Level		Remember alarm	Alarm Status
				MIN	MAX		
Channel 1	<input type="checkbox"/> Input 0V to 10V	0	0 mV	-32768	32767	<input type="checkbox"/>	<input type="checkbox"/>
Channel 2	<input type="checkbox"/> Input 0V to 10V	0	0 mV	-32768	32767	<input type="checkbox"/>	<input type="checkbox"/>
Channel 3	<input type="checkbox"/> Input 0V to 10V	0	0 mV	-32768	32767	<input type="checkbox"/>	<input type="checkbox"/>
Channel 4	<input type="checkbox"/> Input 0V to 10V	0	0 mV	-32768	32767	<input type="checkbox"/>	<input type="checkbox"/>
Channel 5	<input type="checkbox"/> Off	0		-32768	32767	<input type="checkbox"/>	<input type="checkbox"/>
Channel 6	<input type="checkbox"/> Off	0		-32768	32767	<input type="checkbox"/>	<input type="checkbox"/>
Channel 7	<input type="checkbox"/> Off	0		-32768	32767	<input type="checkbox"/>	<input type="checkbox"/>
Channel 8	<input type="checkbox"/> Off	0		-32768	32767	<input type="checkbox"/>	<input type="checkbox"/>

Below the table, the 'Alarm outputs settings' section is visible, showing two rows of settings for current value, alarm value, hysteresis, and alarm status. A 'Filtering' dropdown is set to '1'.

6. Prepare the voltage signal that you want to connect to (for example) input AI 4.

The MOD-8AI module does not provide the power supply to the various types of transducers, e.g. pressure. The outputs of the such transducers should be powered from another source.

7. Measure the prepared voltage signal with a multimeter.

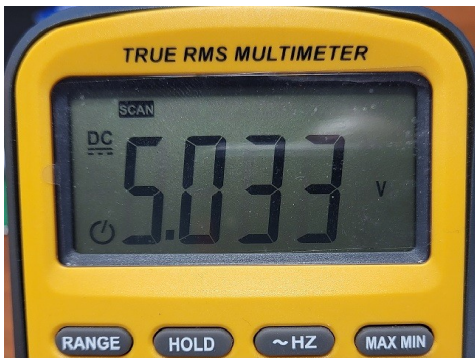

Our voltage signal example: **5,03V**

8. Connect prepared voltage signal for example to AI 4 (channel 4):

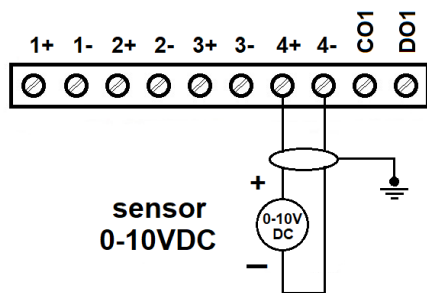

9. Read the value of the voltage AI 4 (Channel 4) in the IO Configurator.

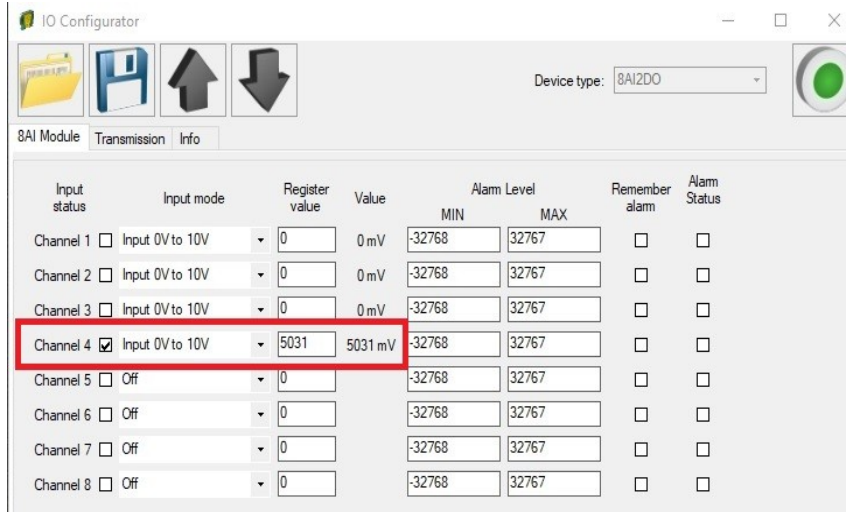

The read value is: 5031mV \approx **5,03V**

10. Set communication parameters in IO Configurator (MOD-8AI is a Modbus slave, client)

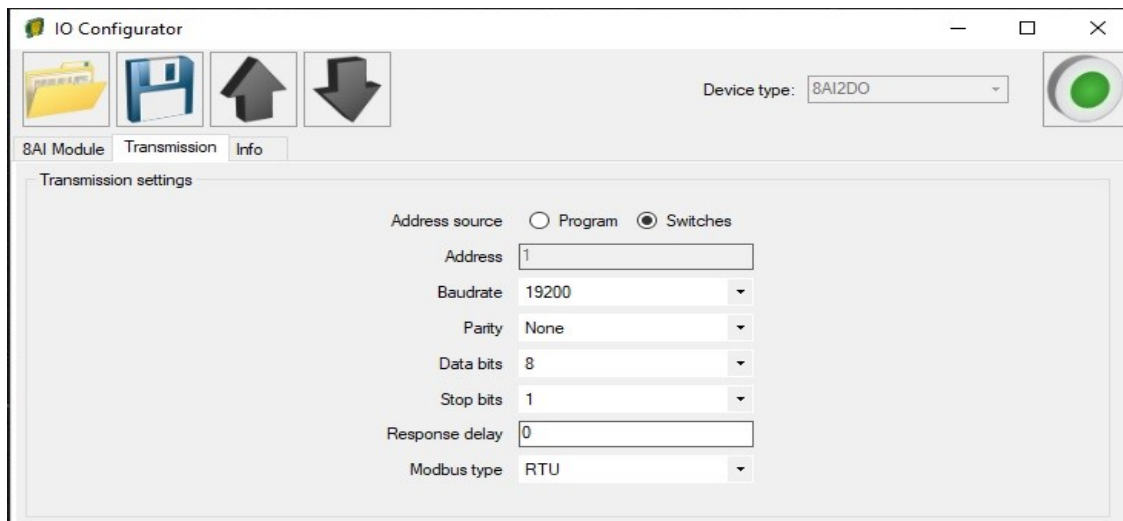

11. Set communication parameters in your **Master Device** (Baudrate, parity, Data bits, Stop bits, Modbus type – the same, Address – other).
12. Disconnect IO Configurator
13. Connect MOD-8AI with your Master Device by RS485:

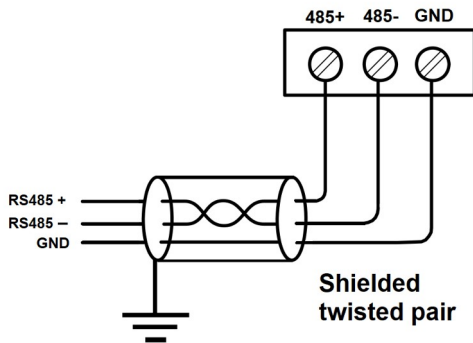

14. Master Device: Send a query to MOD-8AI – read value of analog input AI 4 (Channel 4). Use Modbus function - **Read Holding Registers 03**. Address of the register analog input 4 (AI 4): **55** (dec) or **37** (hex).

40052	51	0x33	Outputs	Read & Write	bit 8 and 9 alarm outputs
30053	52	0x34	Analog 1	Read	Value of analog input in mV for voltage inputs in μ A for current inputs
30054	53	0x35	Analog 2	Read	
30055	54	0x36	Analog 3	Read	
30056	55	0x37	Analog 4	Read	
30057	56	0x38	Analog 5	Read	
30058	57	0x39	Analog 6	Read	
30059	58	0x3A	Analog 7	Read	
30060	59	0x3B	Analog 8	Read	
30061	60	0x3C	Value of 1 alarm input	Read	Current value of output / current for

15. View of communication frame:

A. query to MOD-8AI:

01 03 00 **37** 00 01 35 C4

B. answer from MOD-8AI

01 03 02 **13 A7** F4 CE

13A7 (hex) = 5031 (dec)

16. Read the value of the voltage AI 4 (Channel 4) in Master Device.
In this example Modbus Master is software – QModMaster:

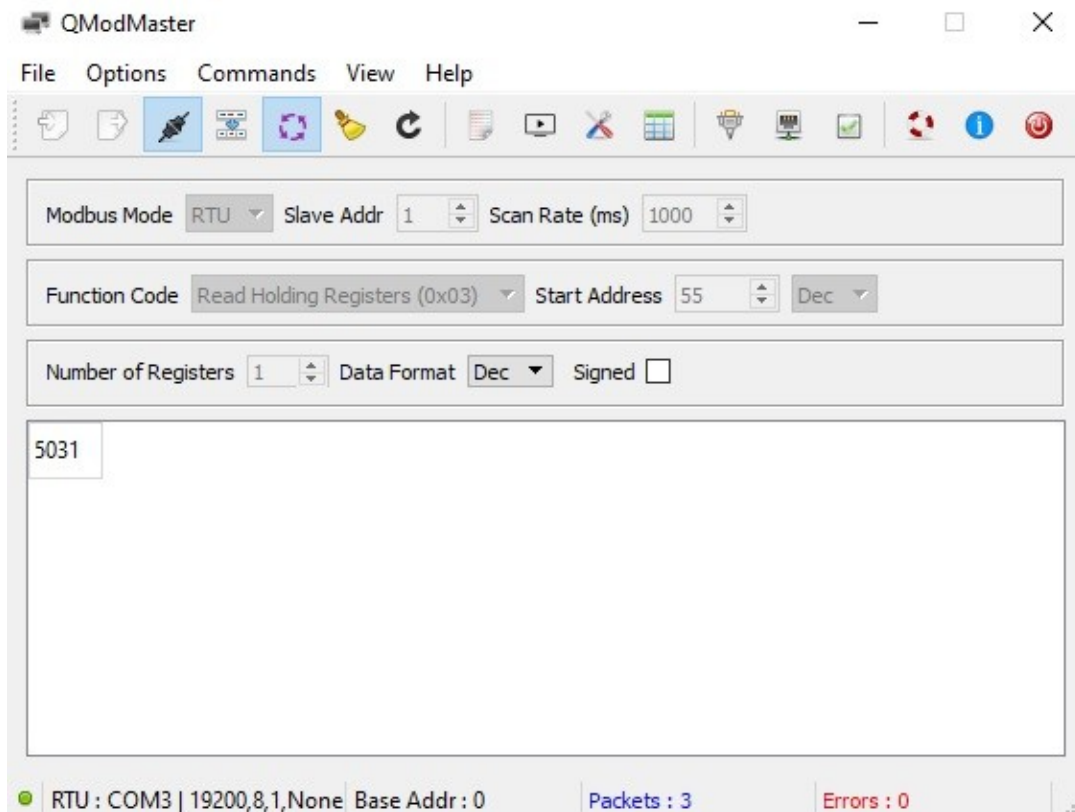

17. The input value is **5031**. The same value like in the IO Configurator (point. 9):
5031mV ≈ **5,03V**